

a-24x

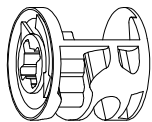

b-24x

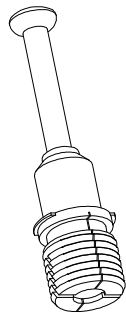

c-24x

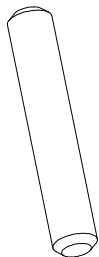

d-6x



e-28x

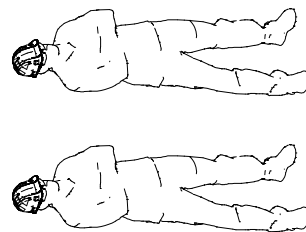
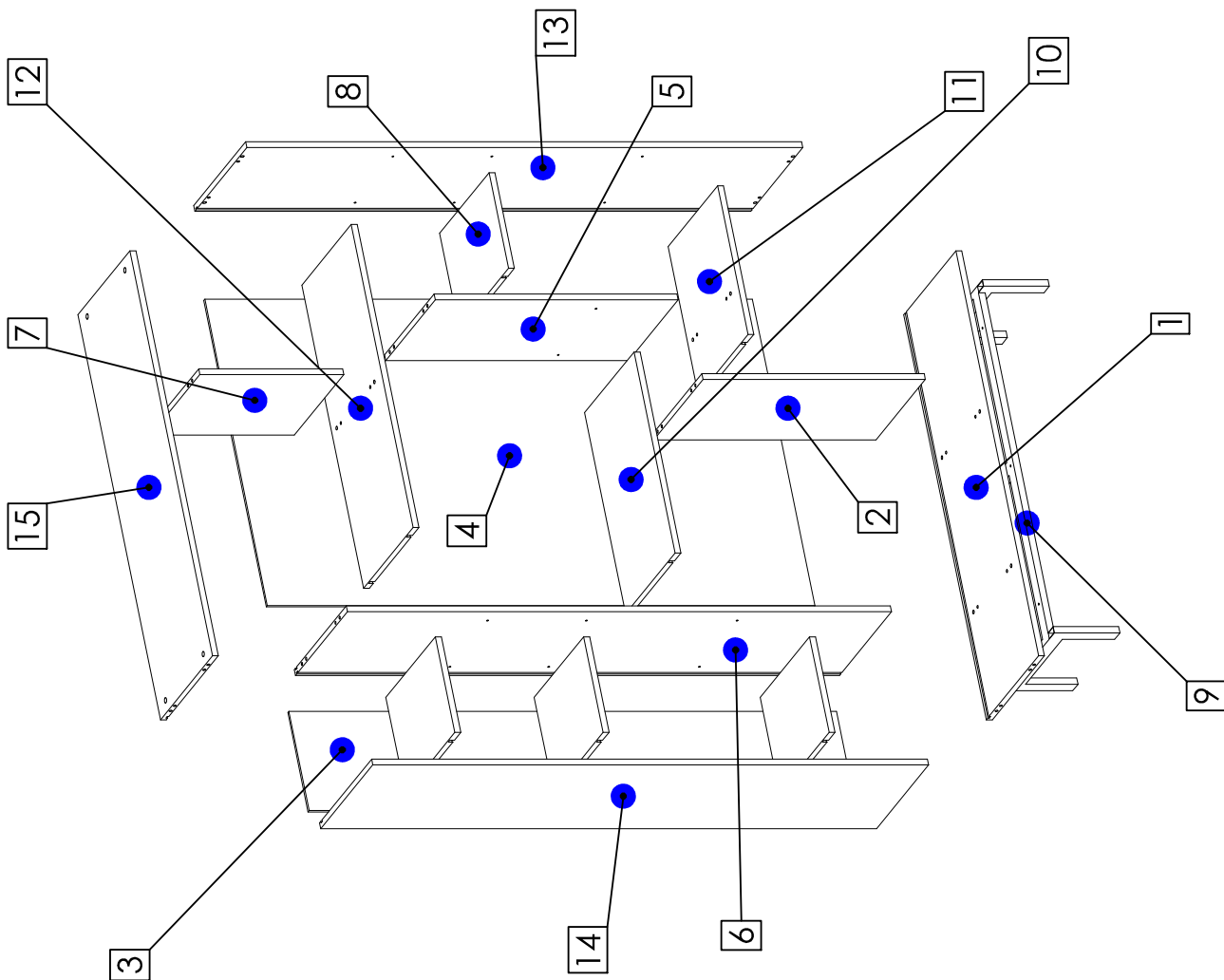

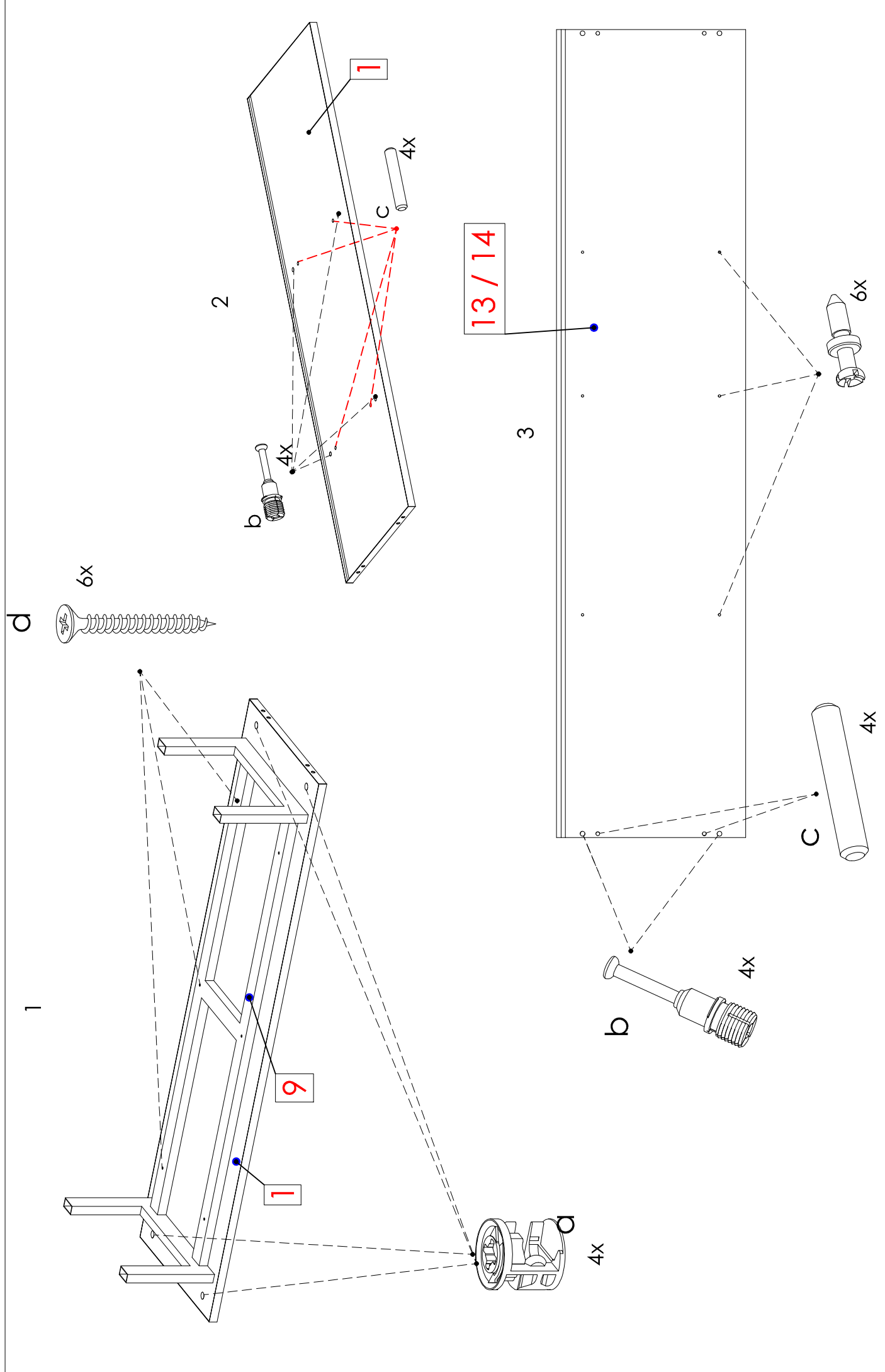

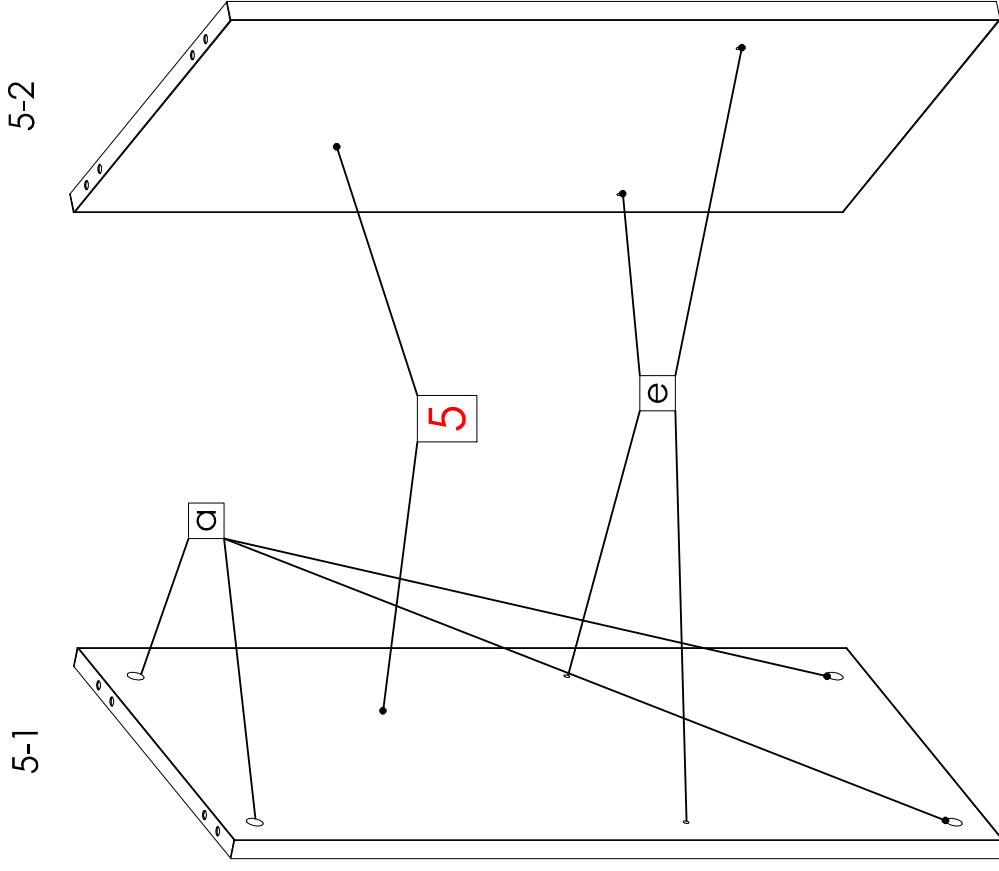
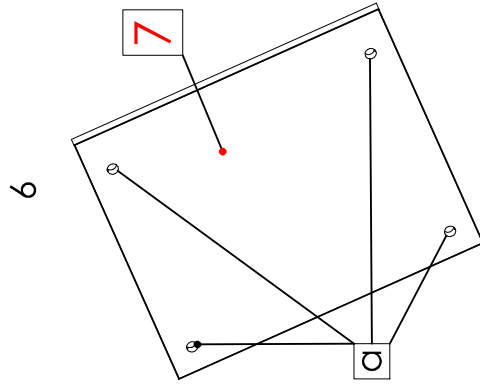
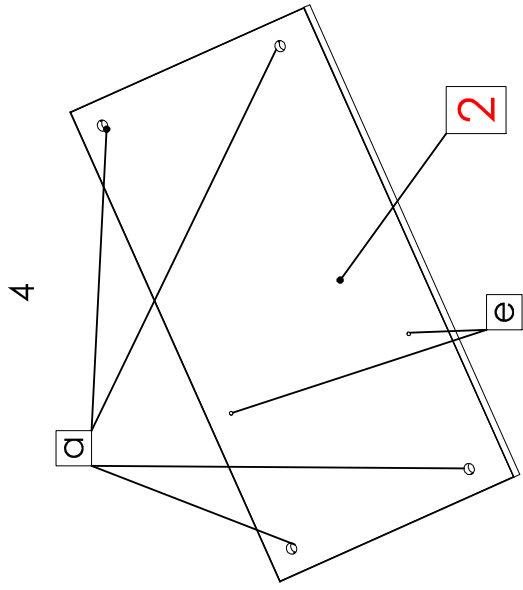

7-1

7-2

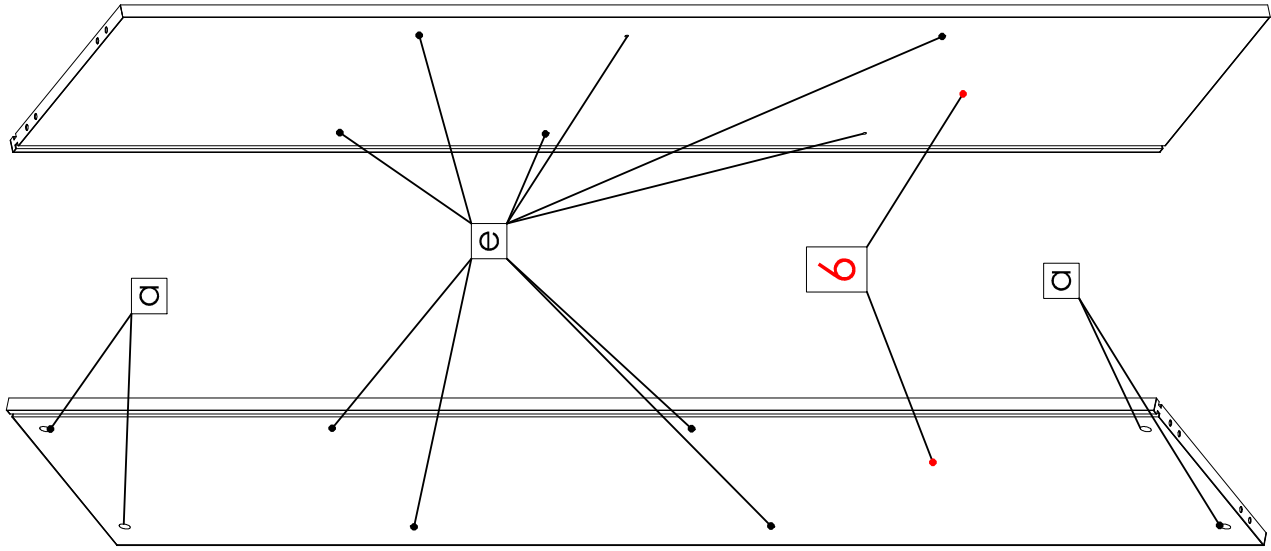

8

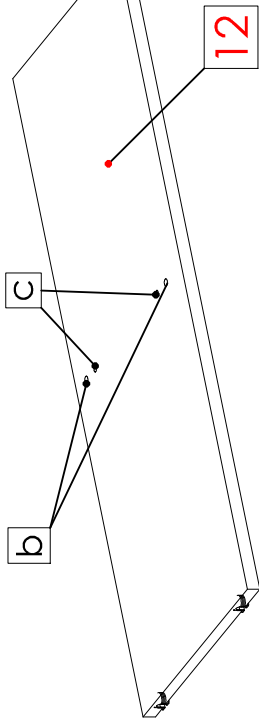

9

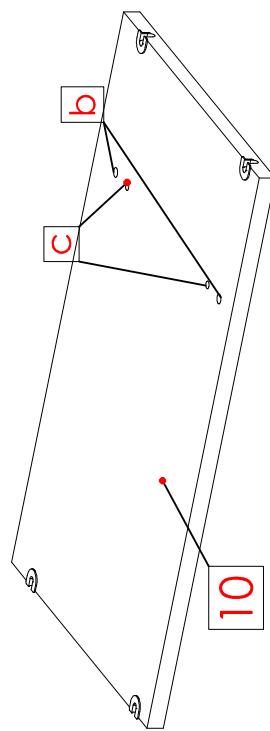

10

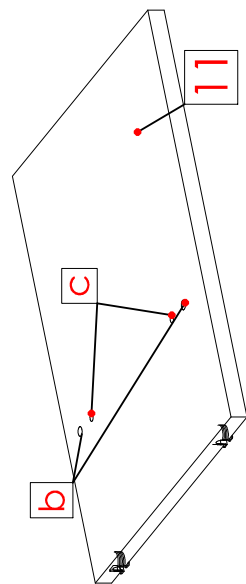

11

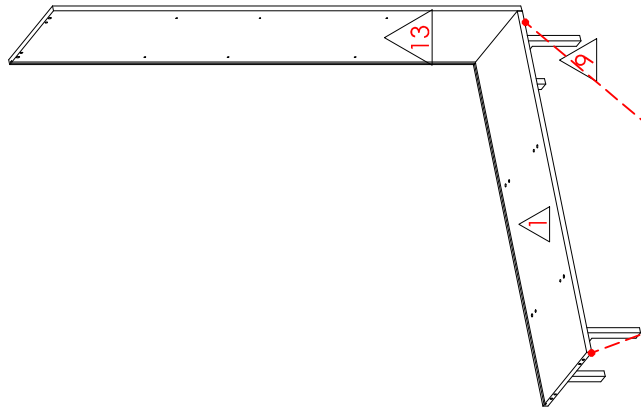

12

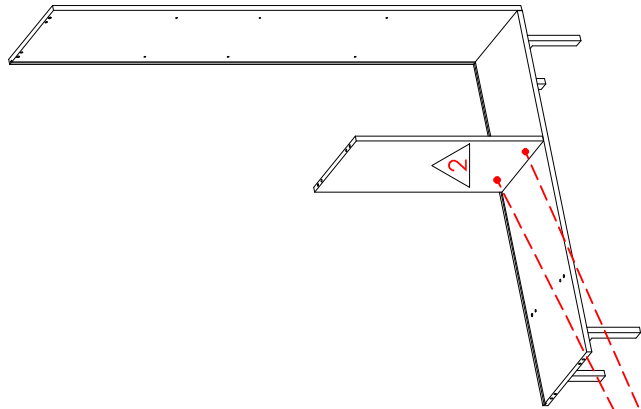

13

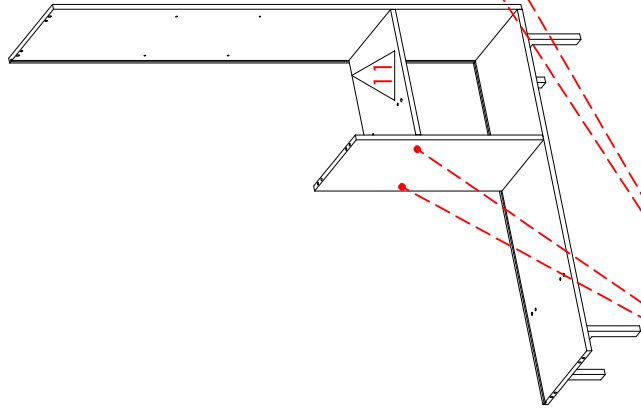

14

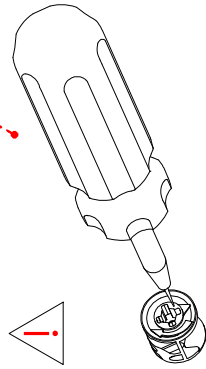
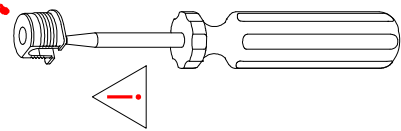
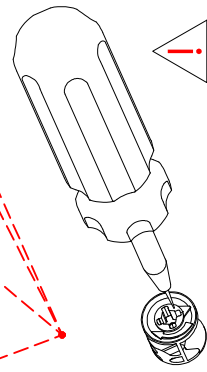
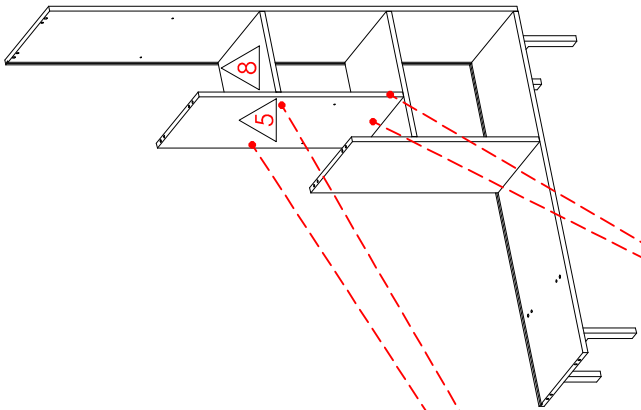

15

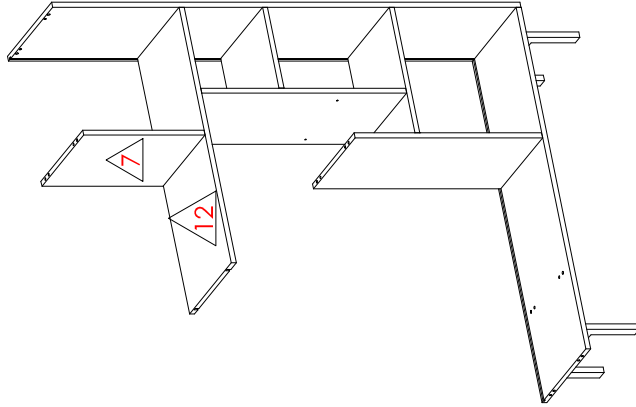

16

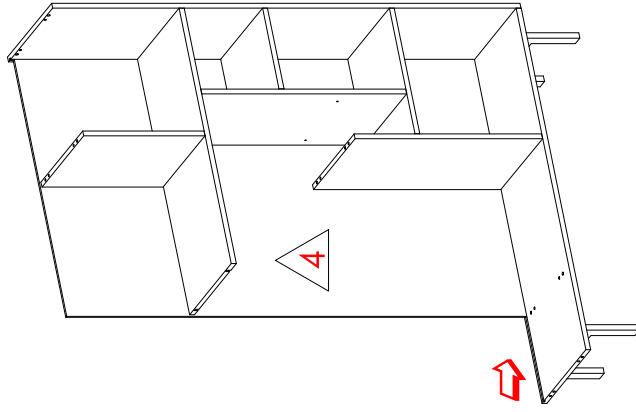

17

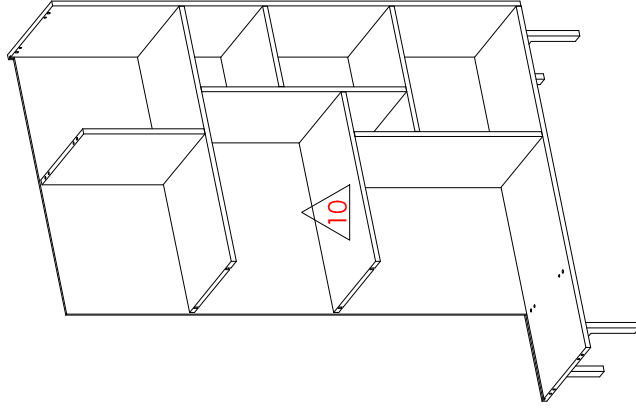

18

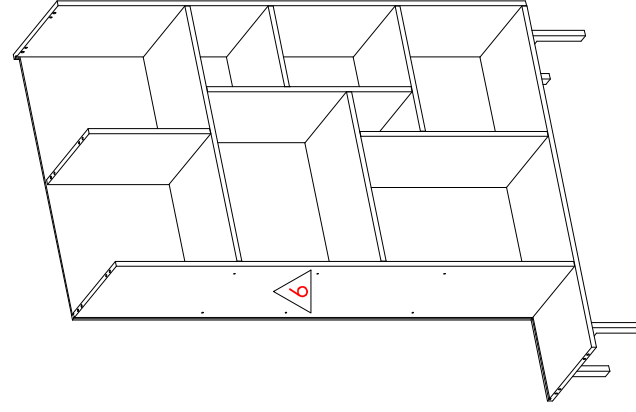

19

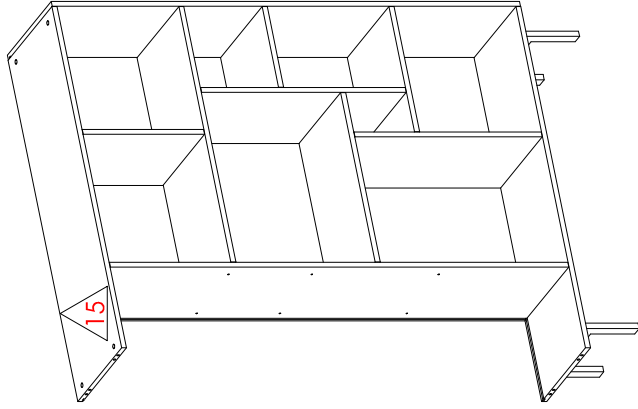

20

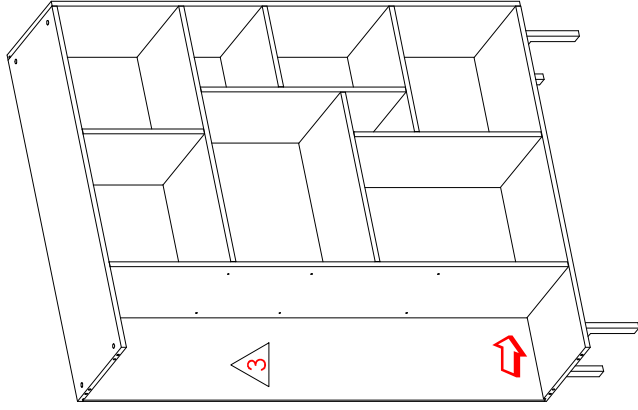

21

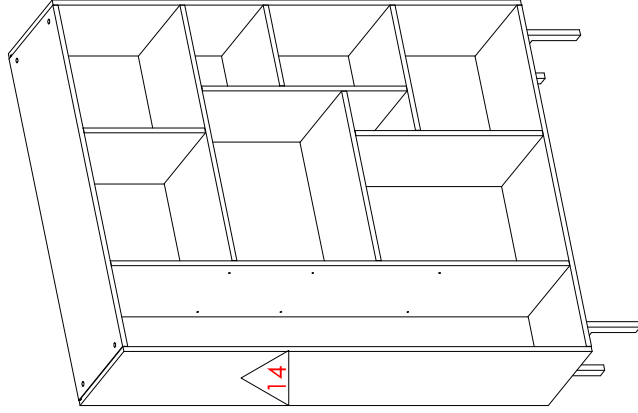

22

