

NO	KOD/CODE	PARÇA ADI	NAME	ADET/PIECE	KUTU/BOX
1	ZSAN001KMD686828	CEKMECE KLAPASI	DRAWER FRONT	1	2
2	ZSAN001KMD687801	UST TABLA	TOP PANEL	1	2
3	ZSAN001KMD687802	ALT TABLA	BOTTOM PANEL	1	2
4	ZSAN001KMD687803	SAG YAN TABLA	END PANEL -RIGHT	1	2
5	ZSAN001KMD687804	SOL YAN TABLA	END PANEL -LEFT	1	2
6	ZSAN001KMD666823	CEKMECE KASASI SAG YAN	DRAWER BOX RIGHT SIDE	1	2
7	ZSAN001KMD666824	CEKMECE KASASI SOL YAN	DRAWER BOX LEFT SIDE	1	2
8	ZSAN001KMD666834	CEKMECE KASASI ARKA KAYIT	DRAWER BOX BACK PANEL	1	2
9	ZSAN001KMD666833	CEKMECE TABANI	DRAWER BASE	1	2
10	ZSAN001KMD687816	ARKALIK	BACK PANEL	1	2
11	ZSANT01KMD215715	AYAK	LEG	4	1

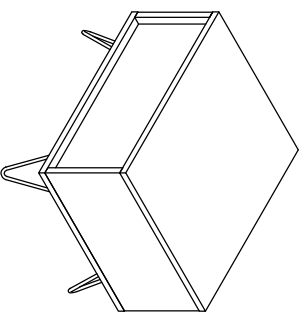

PLEASE RETAIN THE LABEL INFORMATION ON THE PACKAGES. DO NOT START ASSEMBLY IF THERE ARE ANY MISSING ITEMS IN THE PACKAGE.
THE MANUFACTURER IS NOT RESPONSIBLE FOR ANY DAMAGES THAT MAY BE INCURRED DURING THE ASSEMBLY PROCESS AND LATER ON DUE TO THE MISUSE OF BUYERS.
KULLANIM SÜRESİNDE ETİKET BİLGİLERİNİ SAKLAYINIZ. KULLIYIŞI SÜRESİNDE BİRSİK PARÇA YARSA, LÜTFEN MONTAJA BAŞLAMAYINIZ.
MONTAJ ESNASINDA VE DAHA SONRA KULLANICI HATLARINDAN DOĞRUK HASARLARDA ÜRETİCİ FİRMA SORUMLU DEĞİLDİR.

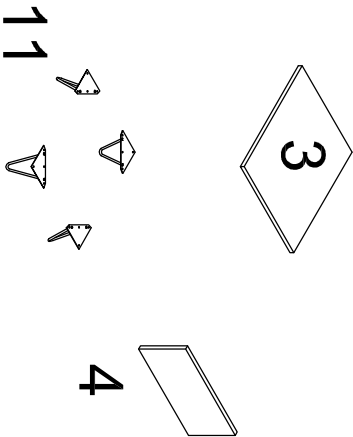
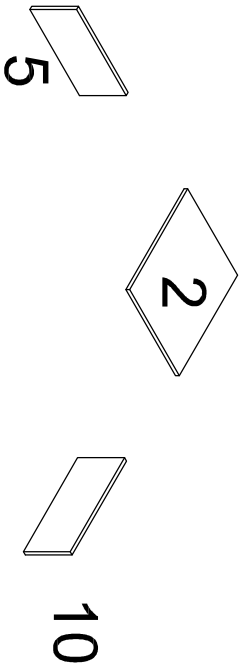
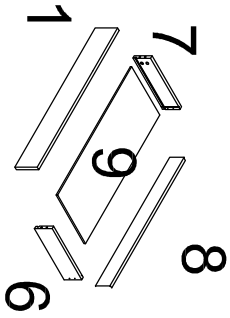

444 6 999

Toll-free information line only
for domestic calls-Türkiye

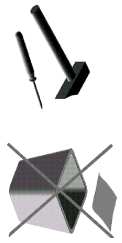
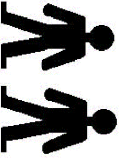

M6,3x13,5
4 X



3,5x35
4 X



4x16
13 X



4x25
1 X



1 X



10 X



12 X

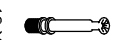

12 X



1 X



1 X

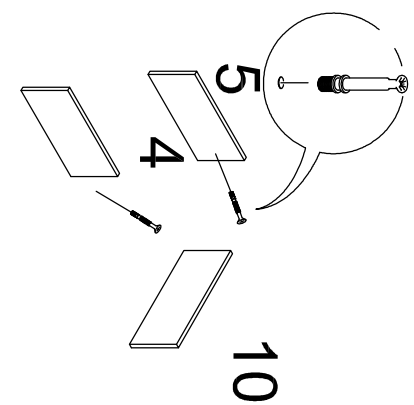

1

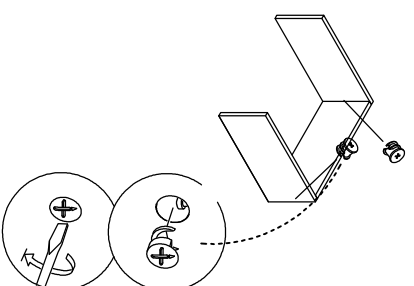

2

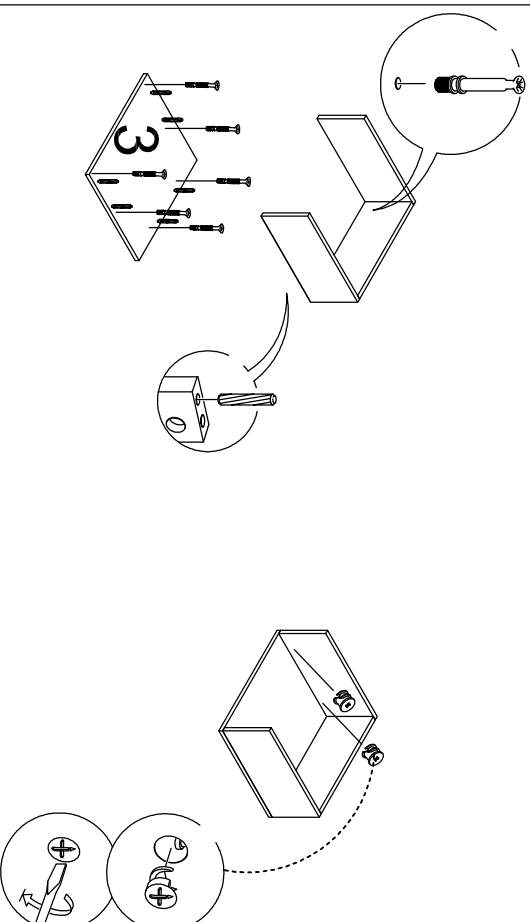

3

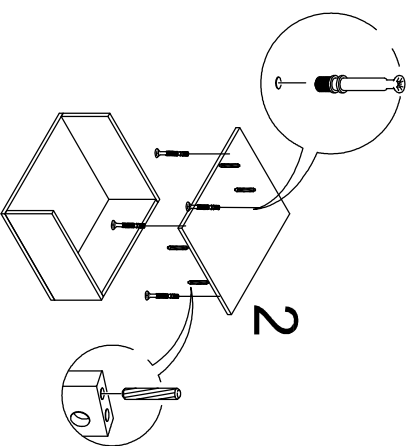

4

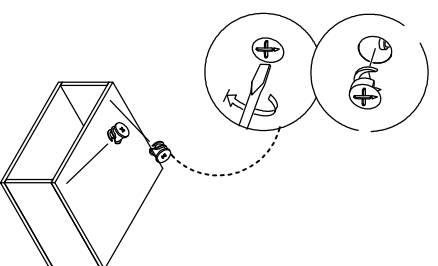

6,3X13,5

