

1

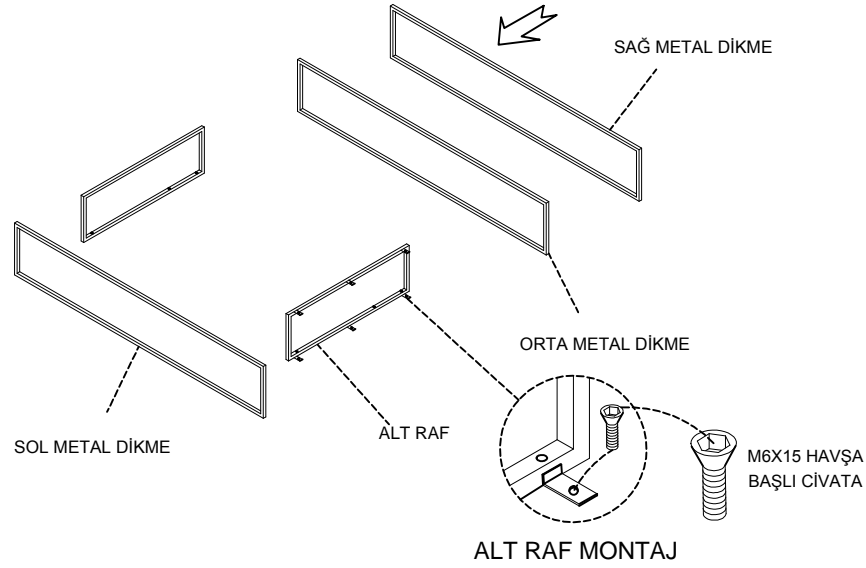

2

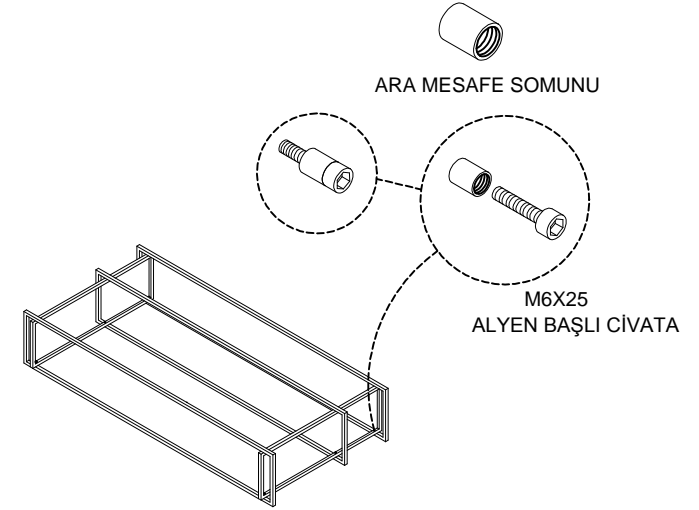

3

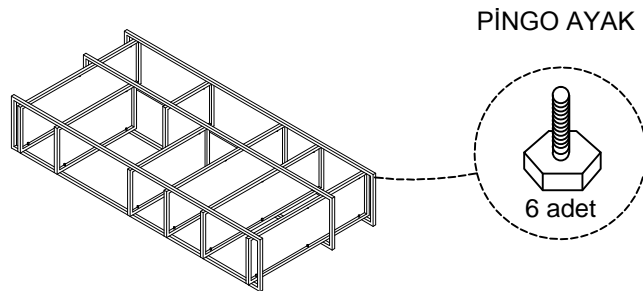

TÜM RAFLARI
M6X25 ALYEN BAŞLI CİVATA
VE ARA MESAFE SOMUNU İLE
MONTE EDİNİZ.

4

DİKKAT : METAL RAFLARI MONTAJINI YAPILIRKEN
AŞAĞIDAKİ DETAYA DİKKAT EDİNİZ

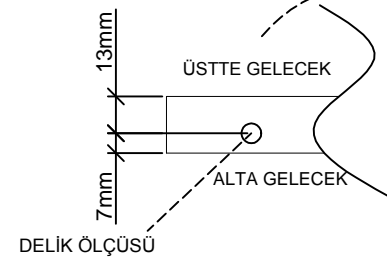

D İ K K A T !!!

CİVATALARI TAMAMEN SIKMADAN ÖNCE
ÜRÜNÜN GÖNYESİNE ALIP DAHA SONRA
5 LİK ALYEN ANAHTARLA BAĞLANTI CİVATALARINI
YERLERİNE İYİCE SIKINIZ.

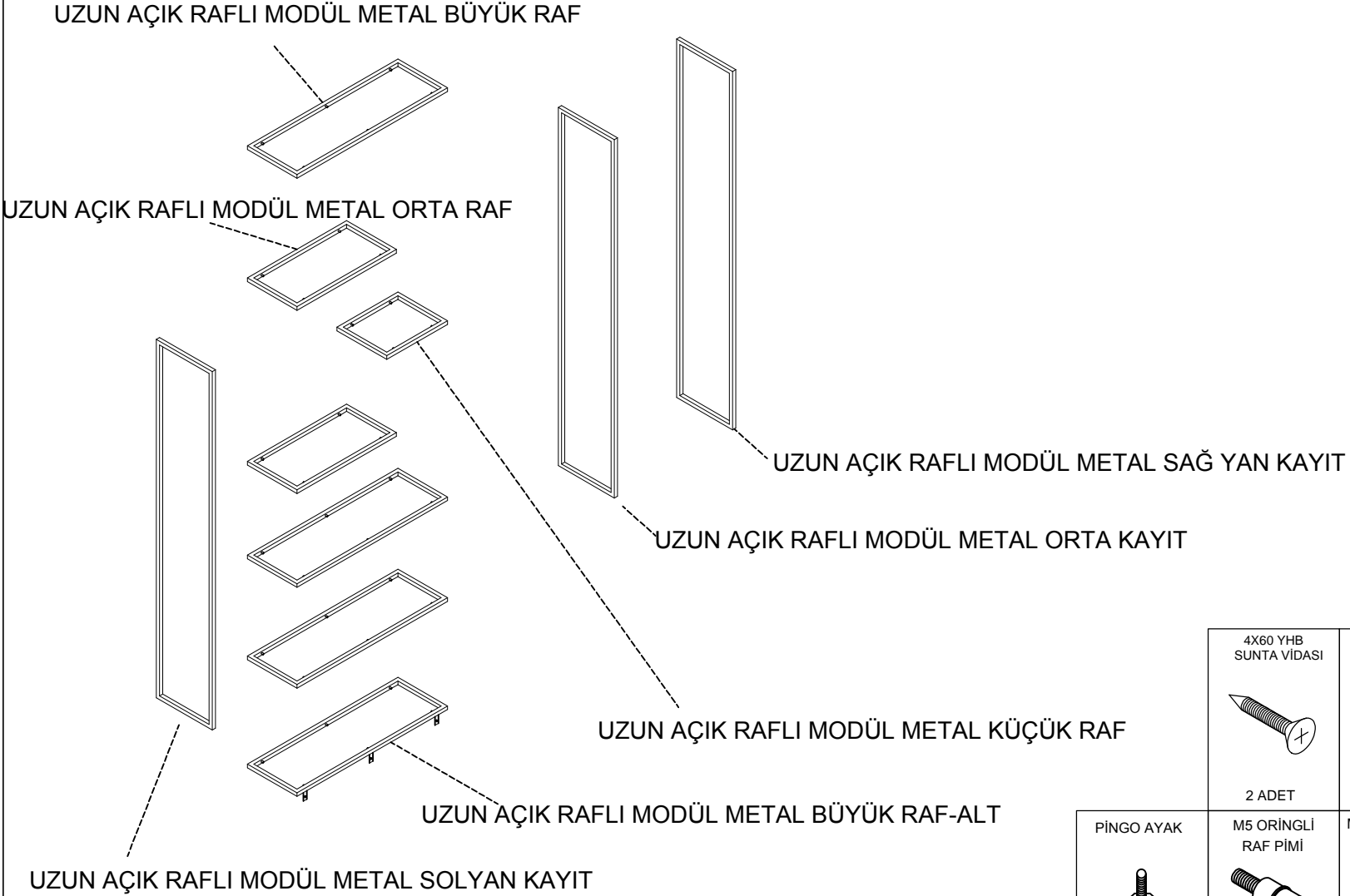

M6X15 HAVŞA
BAŞLI CİVATA

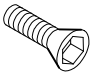

6 ADET

4X60 YHB
SUNTA VİDASI

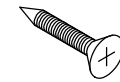

2 ADET

BETON DÜBELİ



2 ADET

UZUN DEPREM
DEMİRİ

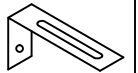

2 ADET

PİNGO AYAK



6 ADET

M5 ORİNGLİ
RAF PİMİ



36 ADET

M6 ARA MESAFE
SOMUNU



36 ADET

M6X25 ALYEN
BAŞLI CİVATA

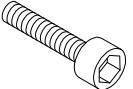

38 ADET



PLEASE RETAIN THE LABEL INFORMATION ON THE PACKAGES. DO NOT START ASSEMBLY IF THERE ARE ANY MISSING ITEMS IN THE PACKAGE.
THE MANUFACTURER IS NOT RESPONSIBLE FOR ANY DAMAGES THAT MAY BE INCURRED DURING THE ASSEMBLY PROCESS AND LATER ON DUE TO THE MISUSE OF BUYERS.
KULLIYERİNDEKİ ETİKET BİLGİLERİNİ SAKLAYINIZ.KULLIYERİNDE EKİKSİK PARÇALAR SA, LÜTFEN MONTAJA BAŞLAMAYINIZ.
MONTAJ ESNASINDA DİĞER ÜRÜNLERİN HATALARINDAN DOĞACAK HASARLARDAN HERİCİ FİRMASININ SORUMLU DEĞİLDİR.

5

M5 ORİNGLİ
RAF PİMİ

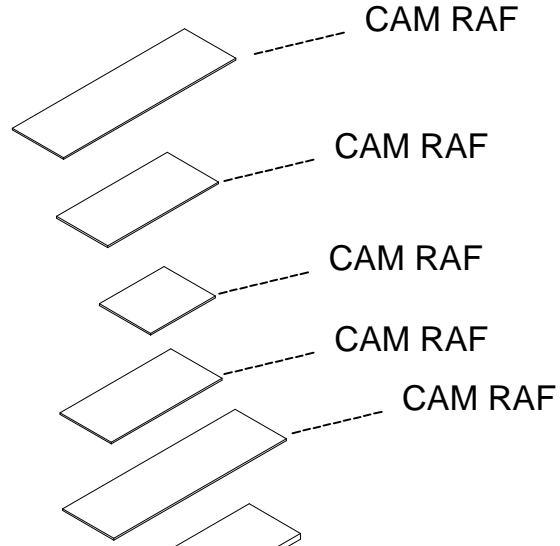
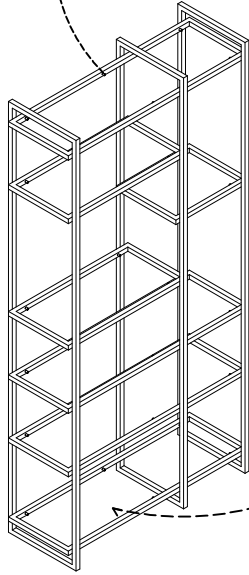
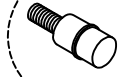

MODELE GÖRE
EN ALT RAFA GELECEK
MALZEMELER
(AHSAP RAF+AYNA
+DİJİTAL BAŞKILI CAM ALTERNATİFLERİ)

**DİKKAT: ÜRÜNÜN DİĞER MODELLERİNDE
TAMAMI AHSAP RAFLI ÜNİTELERDE
BULUNMAKTADIR**

6

M6X25 ALYEN
BAŞLI CİVATA



M6X25 ALYEN
BAŞLI CİVATA

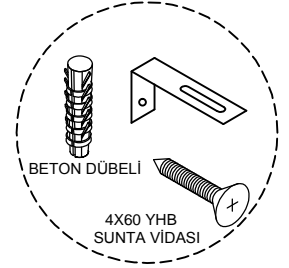
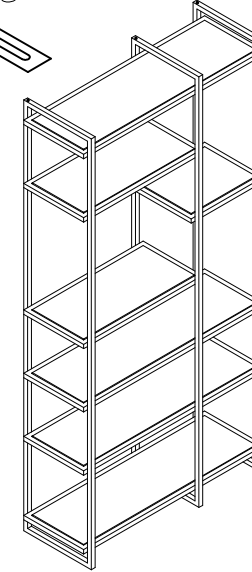
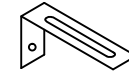
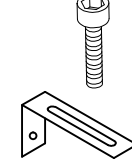

ÜRÜNÜ DUVARA SABİTLEYİNİZ.

**DİKKAT: DEVRİLME RİSKİNE KARŞI KİTAPLIĞI DUVARA MONTELEYİNİZ
(DEPREM DEMİRİ +BETON DÜBELİ + 4X50 YHB SUNTA VİDASI İLE)**